



space



High Reliability Products

# Space Products Guide

Semtech's Space products: Achieve "Mission Success" with ruggedized parts capable of operating in an unforgiving environment

# Semtech's Space Products

Semtech designs and manufactures discrete power products in axial and surface-mount packages as well as custom assemblies in various configurations. These high performance, rugged and reliable products are utilized in a wide range of applications, and are deployed in rockets, satellites, and missiles.

## SPACE

Zener Diodes JANS 1.5 Watt	4
Zener Diodes JANS 5 Watt	6
Rectifier Diodes JANS Standard & Fast Recovery	8
Rectifier Diodes JANS Ultrafast Recovery	10
TVS Diodes 500 Watt Bipolar	12
TVS Diodes 1500 Watt Bipolar	14

### PRODUCTS

- Half wave discrete rectifiers (QPL)
- TVS rectifiers (QPL)
- Zener voltage regulators (QPL)

### JANS – QUALIFIED DIODES/CRITICAL PROGRAMS

- MIL-PRF-19500 / 356, 5W Zener Voltage Regulators (Available in axial lead and surface mount packages)
- MIL-PRF-19500 / 406, 1.5W Zener Voltage Regulators (Available in axial lead and surface mount packages)
- MIL-PRF-19500 / 411, Rectifiers (Available in axial lead packages)
- MIL-PRF-19500 / 420, Rectifiers (Available in axial lead packages)
- MIL-PRF-19500 / 427, Rectifiers (Available in axial lead packages)
- MIL-PRF-19500 / 429, Rectifiers (Available in axial lead packages)
- MIL-PRF-19500 / 477, Rectifiers (Available in axial lead and surface mount packages)
- MIL-PRF-19500 / 516, TVS Devices (Available in axial lead and surface mount packages)



- Traceability to wafer level
- Single diffusion lot
- Single lot date code
- Serialization – Laser mark
- Attribute and variable data available
- Fallout summary provided
- Guaranteed homogeneity
- Up-screening available for non-JANS products





# Robust Design & Construction

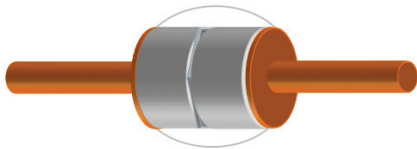

## RECTIFIER DIODE CONSTRUCTION

- Category I eutectic bond
- Passivation – Glass slurry
- Terminations – OFHC copper with hot solder dip for either axial or surface mount

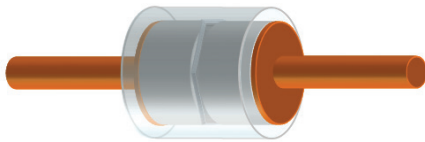
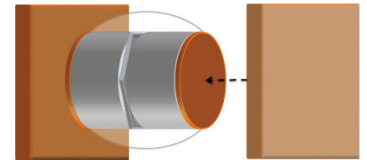

## UNIPOLAR TVS DIODE CONSTRUCTION

- Category I eutectic bond
- Passivation – Die-glass sleeve for added strength
- Terminations – OFHC copper with hot solder dip for axial and solder plate option for surface mount

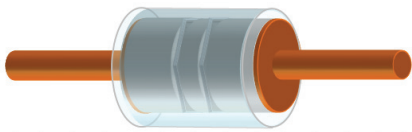
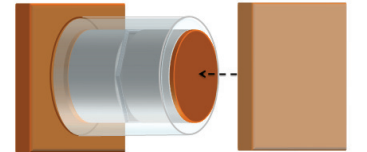

## BIPOLAR TVS DIODE CONSTRUCTION

- Category I eutectic bond
- Passivation – Die-glass sleeve for added strength
- Heat spreader
- Terminations – OFHC copper with hot solder dip for axial and solder plate option for surface mount

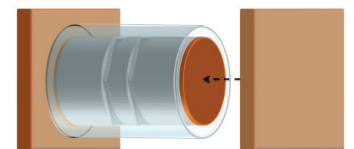

# Zener Diodes

## JANS 1.5 Watt

+175°C  
-65°C



6.2V  
200V



Semtech's Space products listed within this guide conform to MIL-PRF-19500 Appendix H coating thickness and composition requirements.



**AXIAL PACKAGE**

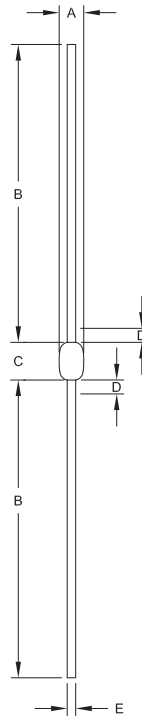

### 1.5 Watt Zener Diodes (Axial)

DIM <sup>N</sup>	Dimensions				Notes
	Inches		Millimeters		
	Min	Max	Min	Max	
A	0.06	0.085	1.52	2.16	-
B	0.8	1.30	20.32	33.02	-
C	0.106	0.16	2.69	4.06	-
D	-	0.05	-	1.27	(1)
E	0.028	0.032	0.71	0.81	-

(1) Lead diameter uncontrolled over this region

Part Number	Description
JANS1N4460	6.2V, 230 mA
JANS1N4460US	Surface Mount Package
JANS1N4461	6.8V, 210 mA
JANS1N4461US	Surface Mount Package
JANS1N4462	7.5V, 191 mA
JANS1N4462US	Surface Mount Package
JANS1N4463	8.2V, 174 mA
JANS1N4463US	Surface Mount Package
JANS1N4464	9.1V, 157 mA
JANS1N4464US	Surface Mount Package
JANS1N4465	10V, 143 mA
JANS1N4465US	Surface Mount Package
JANS1N4466	11V, 130 mA
JANS1N4466US	Surface Mount Package
JANS1N4467	12V, 119 mA
JANS1N4467US	Surface Mount Package
JANS1N4468	13V, 110 mA
JANS1N4468US	Surface Mount Package

Part Number	Description
JANS1N4469	15V, 95 mA
JANS1N4469US	Surface Mount Package
JANS1N4470	16V, 90 mA
JANS1N4470US	Surface Mount Package
JANS1N4471	18V, 79 mA
JANS1N4471US	Surface Mount Package
JANS1N4472	20V, 71 mA
JANS1N4472US	Surface Mount Package
JANS1N4473	22V, 65 mA
JANS1N4473US	Surface Mount Package
JANS1N4474	24V, 60 mA
JANS1N4474US	Surface Mount Package
JANS1N4475	27V, 53 mA
JANS1N4475US	Surface Mount Package
JANS1N4476	30V, 48 mA
JANS1N4476US	Surface Mount Package
JANS1N4477	33V, 43 mA
JANS1N4477US	Surface Mount Package

# Zener Diodes

## JANS 1.5 Watt

+175°C  
-65°C



6.2V  
200V

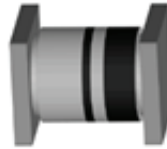

### SURFACE MOUNT PACKAGE

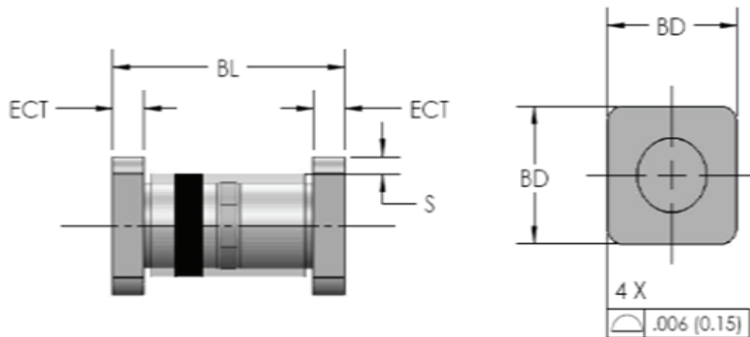

### 1.5 Watt Zener Diodes (Surface Mount)

DIM <sup>N</sup>	Dimensions				Notes
	Inches		Millimeters		
	Min	Max	Min	Max	
BL	0.168	0.200	4.28	5.08	-
ECT	0.019	0.028	0.48	0.71	-
S	0.003	-	-	0.08	-
BD	0.091	0.103	2.31	2.62	-

Part Number	Description
JANS1N4478	36V, 40 mA
JANS1N4478US	Surface Mount Package
JANS1N4479	39V, 37 mA
JANS1N4479US	Surface Mount Package
JANS1N4480	43V, 33 mA
JANS1N4480US	Surface Mount Package
JANS1N4481	47V, 30 mA
JANS1N4481US	Surface Mount Package
JANS1N4482	51V, 28 mA
JANS1N4482US	Surface Mount Package
JANS1N4483	56V, 26 mA
JANS1N4483US	Surface Mount Package
JANS1N4484	62V, 23 mA
JANS1N4484US	Surface Mount Package
JANS1N4485	68V, 21 mA
JANS1N4485US	Surface Mount Package
JANS1N4486	75V, 19 mA
JANS1N4486US	Surface Mount Package
JANS1N4487	82V, 17 mA

Part Number	Description
JANS1N4487US	Surface Mount Package
JANS1N4488	91V, 16 mA
JANS1N4488US	Surface Mount Package
JANS1N4489	100V, 16 mA
JANS1N4489US	Surface Mount Package
JANS1N4490	110V, 13 mA
JANS1N4490US	Surface Mount Package
JANS1N4491	120V, 12 mA
JANS1N4491US	Surface Mount Package
JANS1N4492	130V, 11 mA
JANS1N4492US	Surface Mount Package
JANS1N4493	150V, 9.5 mA
JANS1N4493US	Surface Mount Package
JANS1N4494	160V, 8.9 mA
JANS1N4494US	Surface Mount Package
JANS1N4495	180V, 7.9 mA
JANS1N4495US	Surface Mount Package
JANS1N4496	200V, 7.2 mA
JANS1N4496US	Surface Mount Package

# Zener Diodes

## JANS 5 Watt

+175°C  
-65°C



6.8V  
300V



Semtech's Space products listed within this guide conform to MIL-PRF-19500 Appendix H coating thickness and composition requirements.



**AXIAL PACKAGE**

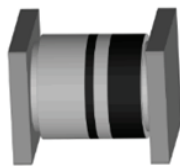

**SURFACE MOUNT PACKAGE**

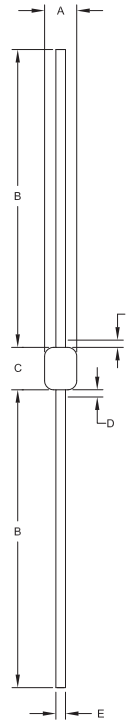

### 5 Watt Zener Diodes (Axial)

Dimensions					
DIM <sup>N</sup>	Inches		Millimeters		Notes
	Min	Max	Min	Max	
A	0.85	1.40	2.16	3.56	-
B	1.00	1.30	25.4	33.0	-
C	0.140	0.185	3.56	4.70	-
D	-	0.30	-	0.80	(1)
E	0.036	0.042	0.91	1.07	-

(1) Lead diameter uncontrolled over this region

Part Number	Description
JANS1N4954	6.8V, 700 mA
JANS1N4954US	Surface Mount Package
JANS1N4955	7.5V, 630 mA
JANS1N4955US	Surface Mount Package
JANS1N4956	8.2V, 580 mA
JANS1N4956US	Surface Mount Package
JANS1N4957	9.1V, 520 mA
JANS1N4957US	Surface Mount Package
JANS1N4958	10V, 475 mA
JANS1N4958US	Surface Mount Package
JANS1N4959	11V, 430 mA
JANS1N4959US	Surface Mount Package
JANS1N4960	12V, 395 mA
JANS1N4960US	Surface Mount Package
JANS1N4961	13V, 365 mA
JANS1N4961US	Surface Mount Package
JANS1N4962	15V, 315 mA
JANS1N4962US	Surface Mount Package

Part Number	Description
JANS1N4963	16V, 294 mA
JANS1N4963US	Surface Mount Package
JANS1N4964	18V, 264 mA
JANS1N4964US	Surface Mount Package
JANS1N4965	20V, 237 mA
JANS1N4965US	Surface Mount Package
JANS1N4966	22V, 216 mA
JANS1N4966US	Surface Mount Package
JANS1N4967	24V, 198 mA
JANS1N4967US	Surface Mount Package
JANS1N4968	27V, 176 mA
JANS1N4968US	Surface Mount Package
JANS1N4969	30V, 158 mA
JANS1N4969US	Surface Mount Package
JANS1N4970	33V, 144 mA
JANS1N4970US	Surface Mount Package
JANS1N4971	36V, 132 mA
JANS1N4971US	Surface Mount Package

# Zener Diodes

## JANS 5 Watt

+175°C  
-65°C



6.8V  
300V

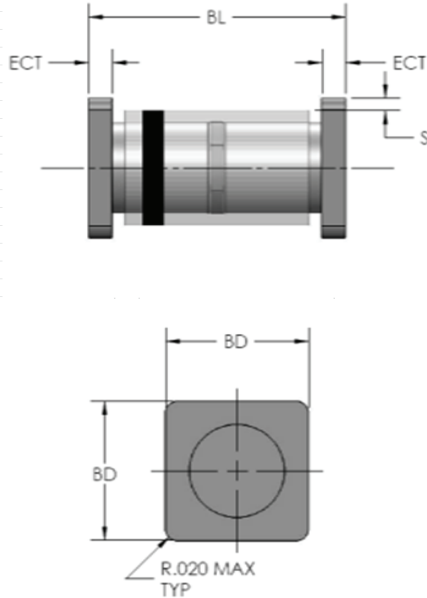

### 5 Watt Zener Diodes (Surface Mount)

Dimensions					
DIM <sup>N</sup>	Inches		Millimeters		Notes
	Min	Max	Min	Max	
BL	0.168	0.200	4.28	5.08	-
ECT	0.019	0.028	0.48	0.71	-
S	0.003	-	-	0.08	-
BD	0.091	0.103	2.31	2.62	-

Part Number	Description
JANS1N4972	39V, 122 mA
JANS1N4972US	Surface Mount Package
JANS1N4973	43V, 110 mA
JANS1N4973US	Surface Mount Package
JANS1N4974	47V, 100 mA
JANS1N4974US	Surface Mount Package
JANS1N4975	51V, 92 mA
JANS1N4975US	Surface Mount Package
JANS1N4976	56V, 84 mA
JANS1N4976US	Surface Mount Package
JANS1N4977	62V, 76 mA
JANS1N4977US	Surface Mount Package
JANS1N4978	68V, 70 mA
JANS1N4978US	Surface Mount Package
JANS1N4979	75V, 63 mA
JANS1N4979US	Surface Mount Package
JANS1N4980	82V, 58 mA
JANS1N4980US	Surface Mount Package
JANS1N4981	91V, 52.5 mA
JANS1N4981US	Surface Mount Package
JANS1N4982	100V, 47.5 mA
JANS1N4982US	Surface Mount Package

Part Number	Description
JANS1N4983	110V, 43 mA
JANS1N4983US	Surface Mount Package
JANS1N4984	120V, 39.5 mA
JANS1N4984US	Surface Mount Package
JANS1N4985	130V, 36.6 mA
JANS1N4985US	Surface Mount Package
JANS1N4986	150V, 31.6 mA
JANS1N4986US	Surface Mount Package
JANS1N4987	160V, 29.4 mA
JANS1N4987US	Surface Mount Package
JANS1N4988	180V, 26.4 mA
JANS1N4988US	Surface Mount Package
JANS1N4989	200V, 23.6 mA
JANS1N4989US	Surface Mount Package
JANS1N4990	220V, 21.6 mA
JANS1N4990US	Surface Mount Package
JANS1N4991	240V, 19.8 mA
JANS1N4991US	Surface Mount Package
JANS1N4992	270V, 17.5 mA
JANS1N4992US	Surface Mount Package
JANS1N4993	300V, 15.6 mA
JANS1N4993US	Surface Mount Package

# Rectifier Diodes

## JANS Standard & Fast Recovery

+175°C  
-65°C



200V  
1000V



Semtech's Space products listed within this guide conform to MIL-PRF-19500 Appendix H coating thickness and composition requirements.

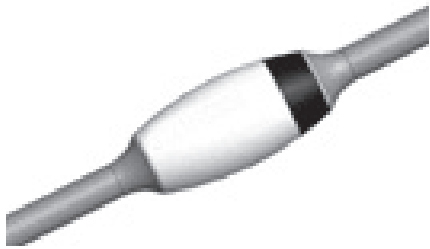

**AXIAL PACKAGE**



**SURFACE MOUNT PACKAGE**

### Standard Recovery

Part Number	Description
JANS1N5614	200V, 1 Amp
JANS1N5616	400V, 1 Amp
JANS1N5618	600V, 1 Amp
JANS1N5620	800V, 1 Amp
JANS1N5622	1000V, 1 Amp
JANS1N5550	200V, 3 Amp
JANS1N5550US	Surface Mount Package
JANS1N5551	400V, 3 Amp
JANS1N5551US	Surface Mount Package
JANS1N5552	600V, 3 Amp
JANS1N5552US	Surface Mount Package
JANS1N5553	800V, 3 Amp
JANS1N5553US	Surface Mount Package
JANS1N5554	1000V, 3 Amp
JANS1N5554US	Surface Mount Package

### Fast Recovery

Part Number	Description
JANS1N5615	200V, 1 Amp
JANS1N5617	400V, 1 Amp
JANS1N5619	600V, 1 Amp
JANS1N5621	800V, 1 Amp
JANS1N5623	1000V, 1 Amp
JANS1N5415	50V, 3 Amp
JANS1N5416	100V, 3 Amp
JANS1N5417	200V, 3 Amp
JANS1N5418	400V, 3 Amp
JANS1N5419	500V, 3 Amp
JANS1N5420	600V, 3 Amp



# Rectifier Diodes

## JANS Standard & Fast Recovery

+175°C  
-65°C



200V  
1000V

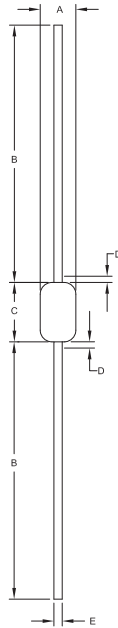

### 3 Amp Standard & Fast Rectifiers (Axial)

Dimensions					
DIM <sup>N</sup>	Inches		Millimeters		Notes
	Min	Max	Min	Max	
A	0.115	0.18	2.92	4.57	-
B	0.9	1.30	22.86	33.02	-
C	0.13	0.3	3.3	7.62	-
D	-	0.03	-	0.80	(1)
E	0.036	0.042	0.92	1.07	-

(1) Lead diameter uncontrolled over this region. Weight = 0.039 oz

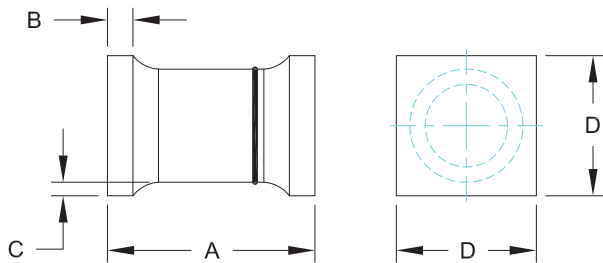

### 3 Amp Standard & Fast Rectifiers (Surface Mount)

Dimensions					
DIM <sup>N</sup>	Inches		Millimeters		Notes
	Min	Max	Min	Max	
A	0.2	0.275	5.08	6.99	-
B	0.019	0.034	0.48	0.86	-
C	0.003	-	0.08	-	-
D	0.137	0.186	3.48	4.72	-

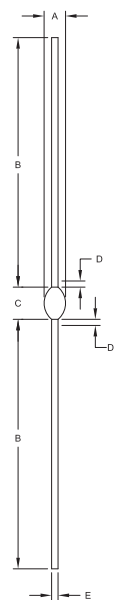

### 1 Amp Standard & Fast Rectifiers

Dimensions					
DIM <sup>N</sup>	Inches		Millimeters		Notes
	Min	Max	Min	Max	
A	0.065	0.110	1.6	2.8	-
B	1.00	1.30	25.4	33.0	-
C	0.14	0.165	3.5	4.2	-
D	-	0.30	-	0.80	(1)
E	0.026	0.033	0.66	0.84	-

(1) Lead diameter uncontrolled over this region

# Rectifier Diodes

## JANS Ultrafast Recovery

+175°C  
-65°C



50V  
150V



Semtech's Space products listed within this guide conform to MIL-PRF-19500 Appendix H coating thickness and composition requirements.

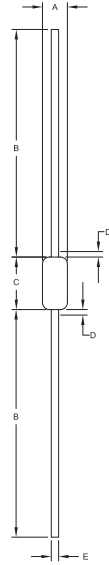

### 3 Amp Ultrafast Rectifiers

Dimensions					
DIM <sup>N</sup>	Inches		Millimeters		Notes
	Min	Max	Min	Max	
A	0.115	0.142	2.92	3.61	-
B	0.90	1.30	22.9	33.0	-
C	0.130	0.3	3.3	7.62	-
D	-	0.30	-	0.80	(1)
E	0.036	0.042	0.91	1.07	-

(1) Lead diameter uncontrolled over this region. Weight = 0.013 oz

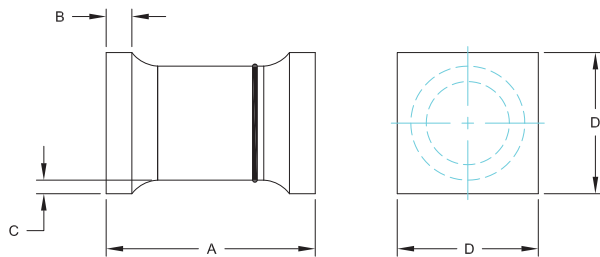

### 1N5807US - 1N5811US

Dimensions		
DIM <sup>N</sup>	Inches	
	Min	Max
A	0.2	0.225
B	0.019	0.028
C	0.003	-
D	0.137	0.148

### Ultrafast Recovery

Part Number	Description
JANS1N5802	50V, I <sub>o</sub> = 1 Amp
JANS1N5802US	Surface Mount Package
JANS1N5804	100V, I <sub>o</sub> = 1 Amp
JANS1N5804US	Surface Mount Package
JANS1N5806	150V, I <sub>o</sub> = 1 Amp
JANS1N5806US	Surface Mount Package
JANS1N5807	50V, I <sub>o</sub> = 3 Amp
JANS1N5807US	Surface Mount Package
JANS1N5809	100V, I <sub>o</sub> = 3 Amp

### Ultrafast Recovery

Part Number	Description
JANS1N5809US	Surface Mount Package
JANS1N5811	150V, I <sub>o</sub> = 3 Amp
JANS1N5811US	Surface Mount Package
JANS1N6638	VR = 125V, I <sub>o</sub> = 300 mA ( <i>Sampling Soon</i> )
JANS1N6638US	Surface Mount Package ( <i>Sampling Soon</i> )
JANS1N6642	VR = 75V, I <sub>o</sub> = 300 mA ( <i>Sampling Soon</i> )
JANS1N6642US	Surface Mount Package ( <i>Sampling Soon</i> )
JANS1N6643	VR = 50V, I <sub>o</sub> = 300 mA ( <i>Sampling Soon</i> )
JANS1N6643US	Surface Mount Package ( <i>Sampling Soon</i> )

# Rectifier Diodes JANS Ultrafast Recovery

+175°C  
-65°C



50V  
150V

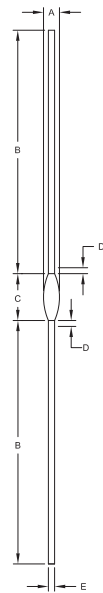

## 1 Amp Ultrafast Rectifiers

Dimensions					
DIM <sup>N</sup>	Inches		Millimeters		Notes
	Min	Max	Min	Max	
A	0.065	0.085	1.65	2.16	-
B	0.70	1.30	17.8	33.0	-
C	0.125	0.250	3.18	6.35	-
D	-	0.30	-	0.80	(1)
E	0.027	0.032	0.69	0.81	-

(1) Lead diameter uncontrolled over this region. Weight = 0.013 oz

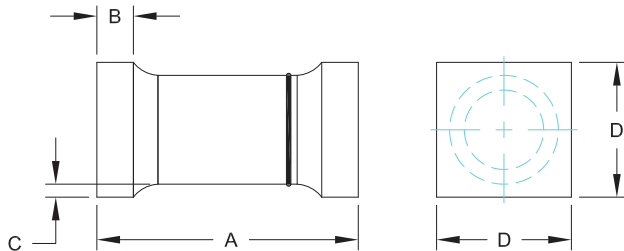

## 1 Amp 1N5802US - 1N5806US

Dimensions		
DIM <sup>N</sup>	Inches	
	Min	Max
A	0.168	0.2
B	0.019	0.028
C	0.003	-
D	0.091	0.103

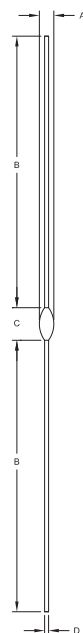

## 1 Amp Switching Rectifiers

Dimensions				
DIM <sup>N</sup>	Inches		Millimeters	
	Min	Max	Min	Max
A	0.056	0.08	1.42	2.03
B	1.00	1.5	25.4	38.1
C	0.13	0.18	3.3	4.57
D	0.018	0.022	0.46	0.56

# TVS Diodes

## JANS 500 Watt Bipolar

+175°C  
-65°C



5.2V  
152V



Semtech's Space products listed within this guide conform to MIL-PRF-19500 Appendix H coating thickness and composition requirements.

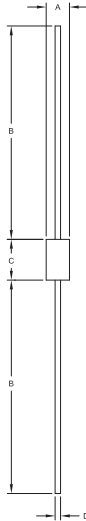

### 500W Bipolar TVS (Axial)

DIM <sup>N</sup>	Dimensions				Notes
	Inches <sup>(1)</sup>		Millimeters		
	Min	Max	Min	Max	
A	0.85	1.40	2.1	3.6	-
B	1.00	1.30	25.4	33.0	-
C	0.140	0.245	3.5	6.3	(2)
D	0.026	0.033	0.66	0.84	-

(1) Controlling dimension is inches

(2) Includes uncontrolled area of device leads

Part Number	Description
JANS1N6102	VR = 5.2V, ID = 100 µA
JANS1N6102US	Surface Mount Package
JANS1N6102A	VR = 5.2V, ID = 100 µA
JANS1N6102AUS	Surface Mount Package
JANS1N6103	VR = 5.7V, ID = 50 µA
JANS1N6103US	Surface Mount Package
JANS1N6103A	VR = 5.7V, ID = 50 µA
JANS1N6103AUS	Surface Mount Package
JANS1N6104	VR = 6.2V, ID = 20 µA
JANS1N6104US	Surface Mount Package
JANS1N6104A	VR = 6.2V, ID = 20 µA
JANS1N6104AUS	Surface Mount Package
JANS1N6105	VR = 6.9V, ID = 20 µA
JANS1N6105US	Surface Mount Package
JANS1N6105A	VR = 6.9V, ID = 20 µA
JANS1N6105AUS	Surface Mount Package
JANS1N6106	VR = 7.6V, ID = 20 µA
JANS1N6106US	Surface Mount Package
JANS1N6106A	VR = 7.6V, ID = 20 µA
JANS1N6106AUS	Surface Mount Package
JANS1N6107	VR = 8.4V, ID = 20 µA
JANS1N6107US	Surface Mount Package
JANS1N6107A	VR = 8.4V, ID = 20 µA
JANS1N6107AUS	Surface Mount Package
JANS1N6108	VR = 9.1V, ID = 20 µA

Part Number	Description
JANS1N6108US	Surface Mount Package
JANS1N6108A	VR = 9.1V, ID = 20 µA
JANS1N6108AUS	Surface Mount Package
JANS1N6109	VR = 9.9V, ID = 20 µA
JANS1N6109US	Surface Mount Package
JANS1N6109A	VR = 9.9V, ID = 20 µA
JANS1N6109AUS	Surface Mount Package
JANS1N6110	VR = 11.4V, ID = 20 µA
JANS1N6110US	Surface Mount Package
JANS1N6110A	VR = 11.4V, ID = 20 µA
JANS1N6110AUS	Surface Mount Package
JANS1N6111	VR = 12.2V, ID = 20 µA
JANS1N6111US	Surface Mount Package
JANS1N6111A	VR = 12.2V, ID = 20 µA
JANS1N6111AUS	Surface Mount Package
JANS1N6112	VR = 13.7V, ID = 1 µA
JANS1N6112US	Surface Mount Package
JANS1N6112A	VR = 13.7V, ID = 1 µA
JANS1N6112AUS	Surface Mount Package
JANS1N6113	VR = 15.2V, ID = 1 µA
JANS1N6113US	Surface Mount Package
JANS1N6113A	VR = 15.2V, ID = 1 µA
JANS1N6113AUS	Surface Mount Package
JANS1N6114	VR = 16.7V, ID = 1 µA
JANS1N6114US	Surface Mount Package

Part Number	Description
JANS1N6114A	VR = 16.7V, ID = 1 µA
JANS1N6114AUS	Surface Mount Package
JANS1N6115	VR = 18.2V, ID = 1 µA
JANS1N6115US	Surface Mount Package
JANS1N6115A	VR = 18.2V, ID = 1 µA
JANS1N6115AUS	Surface Mount Package
JANS1N6116	VR = 20.6V, ID = 1 µA
JANS1N6116US	Surface Mount Package
JANS1N6116A	VR = 20.6V, ID = 1 µA
JANS1N6116AUS	Surface Mount Package
JANS1N6117	VR = 22.8V, ID = 1 µA
JANS1N6117US	Surface Mount Package
JANS1N6117A	VR = 22.8V, ID = 1 µA
JANS1N6117AUS	Surface Mount Package
JANS1N6118	VR = 25.1V, ID = 1 µA
JANS1N6118US	Surface Mount Package
JANS1N6118A	VR = 25.1V, ID = 1 µA
JANS1N6118AUS	Surface Mount Package
JANS1N6119	VR = 27.4V, ID = 1 µA
JANS1N6119US	Surface Mount Package
JANS1N6119A	VR = 27.4V, ID = 1 µA
JANS1N6119AUS	Surface Mount Package
JANS1N6120	VR = 29.7V, ID = 1 µA
JANS1N6120US	Surface Mount Package
JANS1N6120A	VR = 29.7V, ID = 1 µA

# TVS Diodes

## JANS 500 Watt Bipolar

+175°C  
-65°C



5.2V  
152V



### 500W Bipolar TVS (Surface Mount)

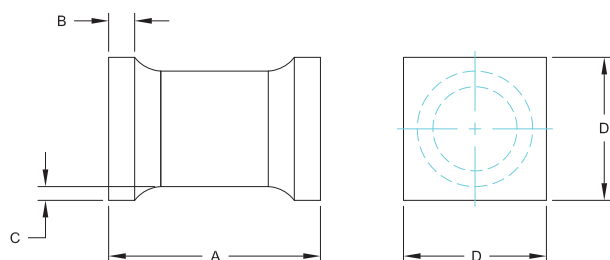

Dimensions		
DIM <sup>M</sup>	Inches	
	Min	Max
A	0.2	0.225
B	0.019	0.028
C	0.003	-
D	0.137	0.148

Part Number	Description
JANS1N6120AUS	Surface Mount Package
JANS1N6121	VR = 32.7V, ID = 1 μA
JANS1N6121US	Surface Mount Package
JANS1N6121A	VR = 32.7V, ID = 1 μA
JANS1N6121AUS	Surface Mount Package
JANS1N6122	VR = 35.8V, ID = 1 μA
JANS1N6122US	Surface Mount Package
JANS1N6122A	VR = 35.8V, ID = 1 μA
JANS1N6122AUS	Surface Mount Package
JANS1N6123	VR = 38.8V, ID = 1 μA
JANS1N6123US	Surface Mount Package
JANS1N6123A	VR = 38.8V, ID = 1 μA
JANS1N6123AUS	Surface Mount Package
JANS1N6124	VR = 42.6V, ID = 1 μA
JANS1N6124US	Surface Mount Package
JANS1N6124A	VR = 42.6V, ID = 1 μA
JANS1N6124AUS	Surface Mount Package
JANS1N6125	VR = 47.1V, ID = 1 μA
JANS1N6125US	Surface Mount Package
JANS1N6125A	VR = 47.1V, ID = 1 μA
JANS1N6125AUS	Surface Mount Package
JANS1N6126	VR = 51.7V, ID = 1 μA
JANS1N6126US	Surface Mount Package
JANS1N6126A	VR = 51.7V, ID = 1 μA
JANS1N6126AUS	Surface Mount Package

Part Number	Description
JANS1N6127	VR = 56.0V, ID = 1 μA
JANS1N6127US	Surface Mount Package
JANS1N6127A	VR = 56.0V, ID = 1 μA
JANS1N6127AUS	Surface Mount Package
JANS1N6128	VR = 62.2V, ID = 1 μA
JANS1N6128US	Surface Mount Package
JANS1N6128A	VR = 62.2V, ID = 1 μA
JANS1N6128AUS	Surface Mount Package
JANS1N6129	VR = 69.2V, ID = 1 μA
JANS1N6129US	Surface Mount Package
JANS1N6129A	VR = 69.2V, ID = 1 μA
JANS1N6129AUS	Surface Mount Package
JANS1N6130	VR = 76.0V, ID = 1 μA
JANS1N6130US	Surface Mount Package
JANS1N6130A	VR = 76.0V, ID = 1 μA
JANS1N6130AUS	Surface Mount Package
JANS1N6131	VR = 83.6V, ID = 1 μA
JANS1N6131US	Surface Mount Package
JANS1N6131A	VR = 83.6V, ID = 1 μA
JANS1N6131AUS	Surface Mount Package
JANS1N6132	VR = 91.2V, ID = 1 μA
JANS1N6132US	Surface Mount Package
JANS1N6132A	VR = 91.2V, ID = 1 μA
JANS1N6132AUS	Surface Mount Package
JANS1N6133	VR = 98.8V, ID = 1 μA

Part Number	Description
JANS1N6133US	Surface Mount Package
JANS1N6133A	VR = 98.8V, ID = 1 μA
JANS1N6133AUS	Surface Mount Package
JANS1N6134	VR = 114.0V, ID = 1 μA
JANS1N6134US	Surface Mount Package
JANS1N6134A	VR = 114.0V, ID = 1 μA
JANS1N6134AUS	Surface Mount Package
JANS1N6135	VR = 121.6V, ID = 1 μA
JANS1N6135US	Surface Mount Package
JANS1N6135A	VR = 121.6V, ID = 1 μA
JANS1N6135AUS	Surface Mount Package
JANS1N6136	VR = 136.8V, ID = 1 μA
JANS1N6136US	Surface Mount Package
JANS1N6136A	VR = 136.8V, ID = 1 μA
JANS1N6136AUS	Surface Mount Package
JANS1N6137	VR = 152.0V, ID = 1 μA
JANS1N6137US	Surface Mount Package
JANS1N6137A	VR = 152.0V, ID = 1 μA
JANS1N6137AUS	Surface Mount Package



# TVS Diodes

## JANS 1500 Watt Bipolar

+175°C  
-65°C



5.2V  
152V



Semtech's Space products listed within this guide conform to MIL-PRF-19500 Appendix H coating thickness and composition requirements.

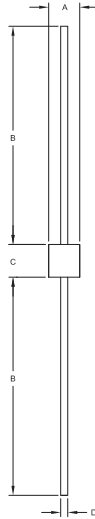

1500W Bipolar TVS (Axial)

DIM <sup>N</sup>	Dimensions				Notes
	Inches <sup>(1)</sup>		Millimeters		
	Min	Max	Min	Max	
A	0.135	0.185	3.40	4.70	-
B	0.900	1.30	22.86	33.02	-
C	0.140	0.195	3.5	4.95	(1)(2)
D	0.036	0.042	0.91	1.07	-

(1) Controlling dimension is inches

(2) Includes uncontrolled area of device leads

Part Number	Description
JANS1N6138	VR = 5.2V, ID = 500 μA
JANS1N6138US	Surface Mount Package
JANS1N6138A	VR = 5.2V, ID = 500 μA
JANS1N6138AUS	Surface Mount Package
JANS1N6139	VR = 5.7V, ID = 300 μA
JANS1N6139US	Surface Mount Package
JANS1N6139A	VR = 5.7V, ID = 300 μA
JANS1N6139AUS	Surface Mount Package
JANS1N6140	VR = 6.2V, ID = 100 μA
JANS1N6140US	Surface Mount Package
JANS1N6140A	VR = 6.2V, ID = 100 μA
JANS1N6140AUS	Surface Mount Package
JANS1N6141	VR = 6.9V, ID = 100 μA
JANS1N6141US	Surface Mount Package
JANS1N6141A	VR = 6.9V, ID = 100 μA
JANS1N6141AUS	Surface Mount Package
JANS1N6142	VR = 7.6V, ID = 100 μA
JANS1N6142US	Surface Mount Package
JANS1N6142A	VR = 7.6V, ID = 100 μA
JANS1N6142AUS	Surface Mount Package
JANS1N6143	VR = 8.4V, ID = 20 μA
JANS1N6143US	Surface Mount Package
JANS1N6143A	VR = 8.4V, ID = 20 μA
JANS1N6143AUS	Surface Mount Package
JANS1N6144	VR = 9.1V, ID = 20 μA

Part Number	Description
JANS1N6144US	Surface Mount Package
JANS1N6144A	VR = 9.1V, ID = 20 μA
JANS1N6144AUS	Surface Mount Package
JANS1N6145	VR = 9.9V, ID = 20 μA
JANS1N6145US	Surface Mount Package
JANS1N6145A	VR = 9.9V, ID = 20 μA
JANS1N6145AUS	Surface Mount Package
JANS1N6146	VR = 11.4V, ID = 20 μA
JANS1N6146US	Surface Mount Package
JANS1N6146A	VR = 11.4V, ID = 20 μA
JANS1N6146AUS	Surface Mount Package
JANS1N6147	VR = 12.2V, ID = 20 μA
JANS1N6147US	Surface Mount Package
JANS1N6147A	VR = 12.2V, ID = 20 μA
JANS1N6147AUS	Surface Mount Package
JANS1N6148	VR = 13.7V, ID = 10 μA
JANS1N6148US	Surface Mount Package
JANS1N6148A	VR = 13.7V, ID = 10 μA
JANS1N6148AUS	Surface Mount Package
JANS1N6149	VR = 15.2V, ID = 5 μA
JANS1N6149US	Surface Mount Package
JANS1N6149A	VR = 15.2V, ID = 5 μA
JANS1N6149AUS	Surface Mount Package
JANS1N6150	VR = 16.7V, ID = 5 μA
JANS1N6150US	Surface Mount Package

Part Number	Description
JANS1N6150A	VR = 16.7V, ID = 5 μA
JANS1N6150AUS	Surface Mount Package
JANS1N6151	VR = 18.2V, ID = 5 μA
JANS1N6151US	Surface Mount Package
JANS1N6151A	VR = 18.2V, ID = 5 μA
JANS1N6151AUS	Surface Mount Package
JANS1N6152	VR = 20.6V, ID = 5 μA
JANS1N6152US	Surface Mount Package
JANS1N6152A	VR = 20.6V, ID = 5 μA
JANS1N6152AUS	Surface Mount Package
JANS1N6153	VR = 22.8V, ID = 5 μA
JANS1N6153US	Surface Mount Package
JANS1N6153A	VR = 22.8V, ID = 5 μA
JANS1N6153AUS	Surface Mount Package
JANS1N6154	VR = 25.1V, ID = 5 μA
JANS1N6154US	Surface Mount Package
JANS1N6154A	VR = 25.1V, ID = 5 μA
JANS1N6154AUS	Surface Mount Package
JANS1N6155	VR = 27.4V, ID = 5 μA
JANS1N6155US	Surface Mount Package
JANS1N6155A	VR = 27.4V, ID = 5 μA
JANS1N6155AUS	Surface Mount Package
JANS1N6156	VR = 29.7V, ID = 5 μA
JANS1N6156US	Surface Mount Package
JANS1N6156A	VR = 29.7V, ID = 5 μA

# TVS Diodes

## JANS 1500 Watt Bipolar

+175°C  
-65°C



5.2V  
152V



### 1500W Bipolar TVS (Surface Mount)

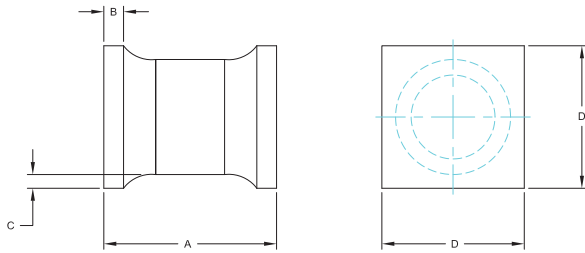

DIM <sup>N</sup>	Dimensions	
	Inches	
	Min	Max
A	0.205	0.245
B	0.019	0.028
C	0.003	-
D	0.183	0.202

Part Number	Description
JANS1N6156AUS	Surface Mount Package
JANS1N6157	VR = 32.7V, ID = 5 μA
JANS1N6157US	Surface Mount Package
JANS1N6157A	VR = 32.7V, ID = 5 μA
JANS1N6157AUS	Surface Mount Package
JANS1N6158	VR = 35.8V, ID = 5 μA
JANS1N6158US	Surface Mount Package
JANS1N6158A	VR = 35.8V, ID = 5 μA
JANS1N6158AUS	Surface Mount Package
JANS1N6159	VR = 38.8V, ID = 5 μA
JANS1N6159US	Surface Mount Package
JANS1N6159A	VR = 38.8V, ID = 5 μA
JANS1N6159AUS	Surface Mount Package
JANS1N6160	VR = 42.6V, ID = 5 μA
JANS1N6160US	Surface Mount Package
JANS1N6160A	VR = 42.6V, ID = 5 μA
JANS1N6160AUS	Surface Mount Package
JANS1N6161	VR = 47.1V, ID = 5 μA
JANS1N6161US	Surface Mount Package
JANS1N6161A	VR = 47.1V, ID = 5 μA
JANS1N6161AUS	Surface Mount Package
JANS1N6162	VR = 51.7V, ID = 5 μA
JANS1N6162US	Surface Mount Package
JANS1N6162A	VR = 51.7V, ID = 5 μA

Part Number	Description
JANS1N6162AUS	Surface Mount Package
JANS1N6163	VR = 56.0V, ID = 5 μA
JANS1N6163US	Surface Mount Package
JANS1N6163A	VR = 56.0V, ID = 5 μA
JANS1N6163AUS	Surface Mount Package
JANS1N6164	VR = 62.2V, ID = 5 μA
JANS1N6164US	Surface Mount Package
JANS1N6164A	VR = 62.2V, ID = 5 μA
JANS1N6164AUS	Surface Mount Package
JANS1N6165	VR = 69.2V, ID = 5 μA
JANS1N6165US	Surface Mount Package
JANS1N6165A	VR = 69.2V, ID = 5 μA
JANS1N6165AUS	Surface Mount Package
JANS1N6166	VR = 76.0V, ID = 5 μA
JANS1N6166US	Surface Mount Package
JANS1N6166A	VR = 76.0V, ID = 5 μA
JANS1N6166AUS	Surface Mount Package
JANS1N6167	VR = 83.6V, ID = 5 μA
JANS1N6167US	Surface Mount Package
JANS1N6167A	VR = 83.6V, ID = 5 μA
JANS1N6167AUS	Surface Mount Package
JANS1N6168	VR = 91.2V, ID = 5 μA
JANS1N6168US	Surface Mount Package
JANS1N6168A	VR = 91.2V, ID = 5 μA

Part Number	Description
JANS1N6168AUS	Surface Mount Package
JANS1N6169	VR = 98.8V, ID = 5 μA
JANS1N6169US	Surface Mount Package
JANS1N6169A	VR = 98.8V, ID = 5 μA
JANS1N6169AUS	Surface Mount Package
JANS1N6170	VR = 114.0V, ID = 5 μA
JANS1N6170US	Surface Mount Package
JANS1N6170A	VR = 114.0V, ID = 5 μA
JANS1N6170AUS	Surface Mount Package
JANS1N6171	VR = 121.6V, ID = 5 μA
JANS1N6171US	Surface Mount Package
JANS1N6171A	VR = 121.6V, ID = 5 μA
JANS1N6171AUS	Surface Mount Package
JANS1N6172	VR = 136.8V, ID = 5 μA
JANS1N6172US	Surface Mount Package
JANS1N6172A	VR = 136.8V, ID = 5 μA
JANS1N6172AUS	Surface Mount Package
JANS1N6173	VR = 152.0V, ID = 5 μA
JANS1N6173US	Surface Mount Package
JANS1N6173A	VR = 152.0V, ID = 5 μA
JANS1N6173AUS	Surface Mount Package

## Rugged Designs for Space

Discrete semiconductors designed for high performance applications in extreme environments. Our components can be found in power supplies, motor drivers, solar power, and power rectification applications.

Semtech designs and manufactures discrete power diodes that are listed in the QPL, both in axial and surface mount (US) configuration. These rectifier diodes, Zener diodes and TVS diodes are also configured into custom modules and ISOPAC® packages.

### SPACE LEVEL TEST FLOW SCREENING NOW AVAILABLE

Semtech's Space Test Flow screening is now available for our discrete semiconductor products. This screening can be applied to both our standard QPL and QPL equivalent diodes that are manufactured in our DSCC certified production facility.

### SEMTECH CORPORATION

Semtech Corporation is a leading supplier of high performance analog, mixed-signal semiconductors and advanced algorithms for high-end consumer, enterprise computing, communications, and industrial equipment. Semtech, publicly traded since 1967, is listed on the Global Select Market under the symbol SMTC and has more than 32 sales and application support offices in 14 countries as well as representatives and distribution support locations in more than 30 countries.

### CUSTOMER CONTACT & KEY SALES OFFICES

#### CORPORATE HEADQUARTERS

Camarillo, California  
805-498-2111

#### NORTH AMERICA

San Jose, California  
408-324-3300

San Diego, California  
858-614-6700

Plano, Texas  
972-231-1606

Burlington, Ontario  
289-856-9200

Saint-Laurent, Quebec  
514-446-2400

#### EUROPE

Rapperswil, Switzerland  
+ 41-55-588-1120

Bristol, England  
+ 44-1454-462200

Courtaboeuf, France  
+ 33-169-282200

Hallbergmoos, Germany  
+ 49-811-998-728-0



For a detailed list of sales representatives in your area please visit

[www.semtech.com/sales](http://www.semtech.com/sales)

find us, like us, follow us



200 Flynn Road, Camarillo, California 93012 • phone: (805) 498-2111